

# CARVER

*Powerful · Musical · Accurate*

## MODEL PM-175

**Magnetic-Field Power Amplifier™**

### OPERATOR'S MANUAL

**IMPORTANT NOTICE**  
*Please read carefully!*

This amplifier was originally manufactured by Carver Corporation. There are references contained within this manual to addresses and telephone numbers that should no longer be used to obtain technical support or factory service.

For any assistance with this product please contact:

**Carver Professional**

A Division of Phoenix Gold International, Inc.  
9300 North Decatur  
Portland, Oregon 97203  
Tel. 503.978.3344  
Fax 503.978.3302

## TABLE OF CONTENTS

	Page
INTRODUCTION . . . . .	.2
Warranty	
Specifications	
Parts of Your Amplifier	
INSTALLATION . . . . .	11
Installer's Checklist	
Placement of Amplifier	
AC Connections	
Amplifier Input/Output Connections	
Dual Channel Operations	
Mono-Bridged Operations	
Determining Balanced or Unbalanced Inputs	
Balanced Cable	
Unbalanced Cable	
Speaker Connections	
Initial Powerup	
Fill Out and Mail Warranty Card	
OPERATION . . . . .	.21
Power	
Protection Systems	
MAINTENANCE . . . . .	.23
General	
Troubleshooting	

5-12-86

Copyright 1986 by Carver Corporation. All rights reserved.

WARNING: TO PREVENT FIRE OR SHOCK HAZARD, DO NOT EXPOSE THIS EQUIPMENT TO RAIN OR MOISTURE.

TO AVOID ELECTRICAL SHOCK, DO NOT OPEN CHASSIS. NO USER-SERVICEABLE PARTS INSIDE. REFER ALL SERVICING TO QUALIFIED PERSONNEL.

CAUTION: Read and follow all safety and operating instructions.

#### CARVER CORPORATION LIMITED WARRANTY

NOTICE: the following warranty is exclusive to the United States only. Please see your Carver dealer or distributor for the correct warranty information in your area or locale.

Carver Corporation is proud of its products which have been built with care using advanced technology and premium parts. Your unit has been crafted to perform properly for many years. Carver Corporation offers to you, the owner of a new Carver product, the following warranty:

The Carver Corporation Warranty for each of its products is in effect for one year from the date of original retail purchase. The Carver Corporation Warranty covers defects in materials and workmanship. However, the following are excluded: a) damage caused during shipment, b) damage caused by accident, misuse, abuse or operation contrary to instructions specified in the Carver Corporation owner's manual, c) units where the serial number has been defaced, modified or removed, d) damage resulting from modification or attempted repair by any person other than authorized by Carver Corporation.

The Carver Corporation Warranty extends to the original owner or subsequent owner(s) during the one-year warranty period so long as the original dated purchase receipt is presented whenever warranty service is required.

If your Carver Corporation product ever requires service, write to or call Carver Corporation (Attention: Customer Service Department), P.O. Box 1237, 20121- 48 Ave W., Lynnwood, WA 98036, (206) 775-6245. You will be directed to an Authorized Carver Corporation Service Station or receive instructions to ship the unit to the factory. Please save the original shipping carton and packaging material in case shipping is required. Please do not ship by Parcel Post. Be sure you have specific authorization from Carver Corporation and include a complete description of the problem, the associated components and connections and a copy of the purchase receipt. Initial costs are not paid by Carver Corporation; return shipping costs will be prepaid if repairs were covered by the scope of this Warranty.

All implied warranties or merchantability and fitness for particular purpose, are limited in duration to the one-year length of this warranty, unless otherwise provided by state law.

Carver Corporation's liability is limited to the repair or replacement, at our option, of any defective product and shall not, in any event include property or any other incidental or consequential damages which may result from the failure of this product.

Some states do not allow limitations on how long an implied warranty lasts and/or do not allow the exclusion or limitation of incidental or consequential damages, so the above limitations or exclusions may not apply to you.

This Warranty gives you specific legal rights, and you may also have other rights which vary from state to state. We suggest that you attach your purchase receipt to this Warranty and keep these in a safe place. Thank you for your choice of a Carver Corporation product.

Carver Corporation  
20121 -48th Ave. W.  
P.O. Box 1237  
Lynnwood, Washington 98036  
(206) 775-1202

Congratulations on the purchase of your professional PM-175 Amplifier. It represents the latest technology in Carver's patented Magnetic Field Power Supply. This efficient supply coupled with a unique amplifier design provide you with the very best in performance. Because of the specially designed protection systems you can be assured your valuable speakers and amplifier will be protected.

Its lightweight and rugged construction makes it ideal for touring and permanent installations. We are proud of our track record for excellent performance and proven reliability. The high quality standards Carver products provide is the quality that our customers have come to expect.

A handwritten signature in cursive script that reads "Bob Carver". The signature is fluid and elegant, with a long, sweeping underline that extends to the right.

Bob Carver

SPECIFICATIONS: CARVER PM-175

Power: 8 ohms, 175 w/channel 20-20kHz  
both channels driven with no more than 0.5% THD

4 ohms, 250 w/channel 20-20kHz  
both channels driven with no more than 0.5% THD

2 ohms 300 w/channel 20-20kHz  
both channels driven with no more than .5% THD

Bridging: 500 watts into 8 ohms  
400 watts into 16 ohms

THD-less than 0.5% at any power level from 20 mW to clipping

IM Distortion less than 0.1% SMPTE

Frequency Bandwidth: 5Hz-80kHz

Gain: 29 dB

Input Sensitivity: 1.5 Vrms

Damping: 200 at 1kHz

Slew rate: 25V/micro second

Noise: Better than 115dB below 175 watts, A-weighted

Inputs: Balanced to ground, XLR or TRS phone jacks

Input Impedance: 15k ohm each leg

Compatible with 25 V and 70 V systems

Mounting: Standard 19" rack with 3.5" space

Height: 3.5"

Width: 19"

Depth: (front to back of chassis): 11.56"

Weight: 19 lbs.

FIG.1-A FEATURES AND FUNCTIONS

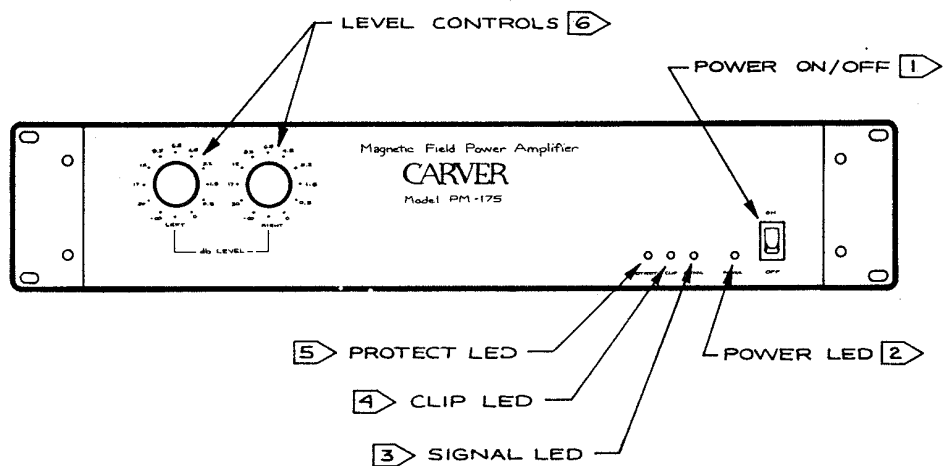

1. POWER ON/OFF

This switch powers up the amplifier with a "slow startup" eliminating a turn-on current surge.

2. POWER LED

Upon startup, the lit green LED indicates the amplifier is ready for operation.

3. SIGNAL LED

The Signal LED indicates the presence of audio greater than 100 mW at the output of either the left or right channel. This LED is beneficial in system checkout and monitoring.

#### 4. CLIP LED

The amber Clip LED will flash at the point of clipping for either the right or left channel. When the Clip LED flashes it indicates that the headroom of the amplifier has been exhausted.

#### 5. PROTECT LED

If the Protect LED is brightly lit, then the amplifier is either being driven into a short-circuited load, or with excessive high frequency (non-musical) signals. The Protect LED will go out if the fault condition is removed or corrected.

If the Protect LED is dimly lit for more than a few seconds, then a fault condition has occurred within the amplifier. It indicates that the power supplies have been automatically limited to an extremely low output level. This prevents the power supply or amplifier failure from damaging the loudspeakers. See Troubleshooting section.

#### 6. LEVEL CONTROLS

The Input Level Controls exist for each channel to progressively reduce the amplifier's input sensitivity. Turn fully clockwise for maximum sensitivity. Each control has eleven detents for precise adjustment without tracking-induced variations in level settings between channels. The left Level Control provides the control during mono-bridged operation. The controls also allow for easy return to predetermined settings with minimum error.



FIG. 1-B FEATURES AND FUNCTIONS

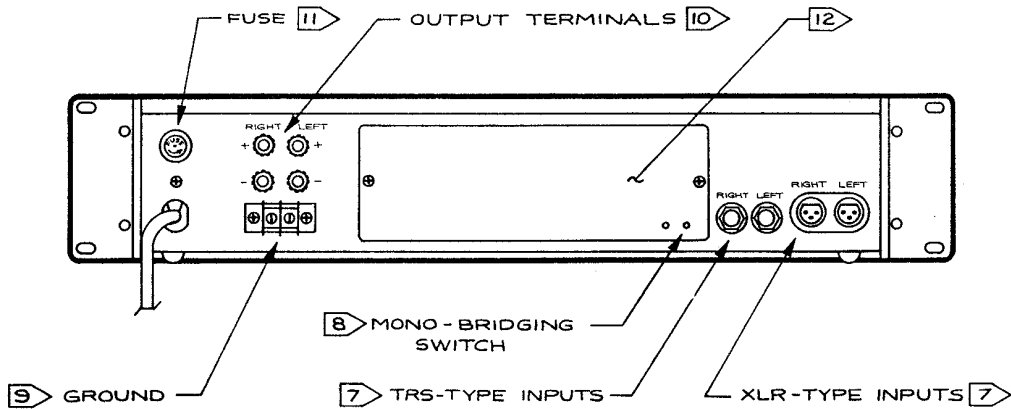

## 7. INPUTS

Signals to drive the PM-175 are supplied to either a dual differentially balanced pair of female XLR connectors or a pair of TRS 1/4-inch phone jacks. Both styles of connectors have the same input impedance: 15K ohms each leg balanced to ground for a total input impedance of 30K ohms. The input overload point for the line amplifier is 7 volts RMS. This ensures full compatibility with all modern signal sources, for both input overload and an optimum input signal to noise ratio.

The balanced XLR and TRS inputs allow single-ended (unbalanced) input operation without switches or adaptors. The only thing required is a set of properly wired signal cables. See Amplifier Input/Output Connections section. For each channel the XLR and the TRS input connectors on the PM-175 are wired in parallel to allow signals to be passed on when cascading multiple amplifier arrays.

#### 8. MONO-BRIDGING SWITCH

This switch is used for operating the PM-175 as a mono (single channel) amplifier. Before operating the PM-175 in mono-bridged mode, this switch must be pushed to the recessed position to invert the left channel drive signal. Gently push the switch in with a narrow screwdriver. Never activate this switch with the amplifier turned ON. To resume dual channel operation, push the switch to its released position.

#### 9. GROUND

A small barrier strip provides a means of altering the grounding scheme of the PM-175. When it comes from the factory, a jumper bar connects the amplifier ground to the amplifier chassis. For normal operation the jumper should remain in place. Removing the jumper may be helpful in solving certain ground-loop hum and noise problems. Removing the jumper leaves a 0.1 uf capacitor in parallel with a 27K ohms resistor between the amplifier ground and the chassis.

#### 10. OUTPUT TERMINALS OR BINDING POSTS

The PM-175's speaker connections are two vertical pairs of five-way binding posts that supply output to the loudspeakers for both dual-channel and mono-bridged operation. The output binding posts accept both single-and dual-banana plugs, spade lugs and stripped or tinned leads.

#### 11. FUSE

REPLACE WITH THE SAME TYPE AND RATING ONLY (MDX 7 or 7A, slo-blo equivalent). The PM-175's fuse type and value allow full dynamic range and allow the amplifier to track the most powerful musical waveforms without compromising the safety of the transformer and triac control circuitry. Never replace the fuse with a different type or rating. Never use a fuse bypass or "cheater". Doing either of these can result in serious amplifier damage and will void the warranty. Make sure the AC line cord is unplugged before replacing the fuse. If the fuse blows immediately after initial replacement, remove the amplifier for servicing.

#### 12. ACCESSORY MODULE PANEL

This panel may be removed by qualified service personnel for the purpose of installing proposed signal processing modules, ie. crossovers, compressors, noise gates.

Consult your Carver Professional Products Dealer for the type and availability.

## INSTALLER'S CHECKLIST

1.  Placement of Amplifier.
2.  AC Connections
3.  Amplifier Input/Output Connections
4.  Initial Power up
5.  Fill Out and Mail Warranty Card.

Keep the carton and packing material your amplifier came in. For shipping and service shipment the best container is the original carton.

### 1. CHECK PLACEMENT OF AMPLIFIER

If the PM-175 will be used in mobile sound systems, be sure it is securely rack mounted in an equipment rack or enclosure.

Air must be free to enter the intake ports on the side panels and exhaust through the top.

In a permanent installation where the PM-175 is housed in a special amp room, be sure the room has adequate ventilation.

When mounting equipment in a case or rack, it is a good practice to install the heaviest components in the bottom of the enclosure. This helps stabilize the enclosure during handling.

### Mobile Rack Installation

The PM-175 is completely rack-mountable and ready to be installed in any standard equipment rack, road/flight case or in any other type of rack mount enclosure.

## 2. [ ] AC CONNECTIONS

BE SURE POWER SWITCH IS OFF.

The PM-175 should be connected to an AC outlet or receptacle rated for no less than 800 W. If your sound system uses several amplifiers, then be sure your power bar, outlet strip or special power block can safely handle the total maximum wattage of all the sound system components.

Although output power specifications are conditional to having an AC line voltage of 120V/60Hz (stable), your amplifier will operate on AC lines voltages from 100V to almost 140V.

If the outlets used to power the system are exposed to foot traffic, secure the plugs to the outlet and the AC line to the wall/floor with tape. This aids in preventing accidental disconnection.

If an extension cord is used, be sure it is the three-prong (grounded) type and 12 gauge or heavier. The longer the extension cord, the heavier the gauge required for safety and minimum line loss.

## 3. [ ] AMPLIFIER INPUT/OUTPUT CONNECTIONS

### DUAL CHANNEL OPERATIONS

The PM-175 can be operated with both channels amplifying a stereo pair of drive signals or two signals independently in dual channel mode. Also bi-amplified/multi-amplified loudspeaker systems will take advantage of the dual-channel mode of operation when driving separate low frequency/upper frequency elements.

With the power for the PM-175 and other components in the system completely off, connect the cables that run from the outputs of the mixer/preamp or crossover to the appropriate

left/right channel inputs on the PM-175. Figure 2.

Be sure that the connectors are firmly in their respective jacks. Connect the speaker wires between the output terminals of the amplifier and the loudspeakers, being careful to maintain the proper speaker phasing. (Figure 2). The PM-175 should be connected to loudspeakers with a nominal impedance of 4-ohms or greater.

In Figure 2, the left-main output of the mixing console is connected to the left-channel input of the PM-175. The right-main output of the mixing console is connected to the right-channel of the amplifier in a stereo configuration.

FIG. 2 DUAL CHANNEL OPERATION

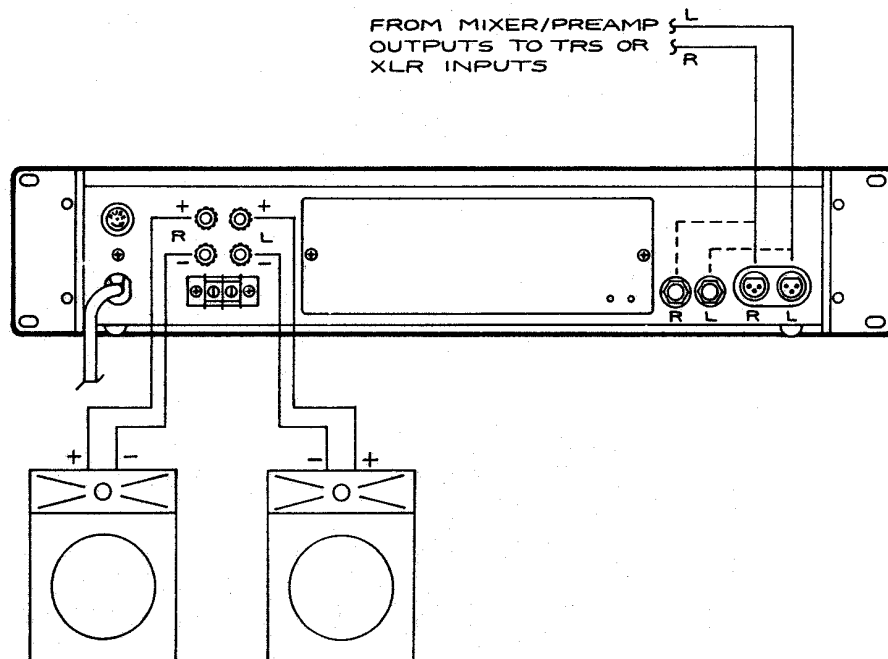

If your sound system uses bi-amplified or multi-amplified loudspeakers, make connections from the high frequency output of the crossover to the high frequency amplifier's inputs. Also make connections from the low-frequency output of the crossover to the low frequency amplifier's inputs. Figure 3.

FIG. 3 BI-AMPLIFIED OPERATION

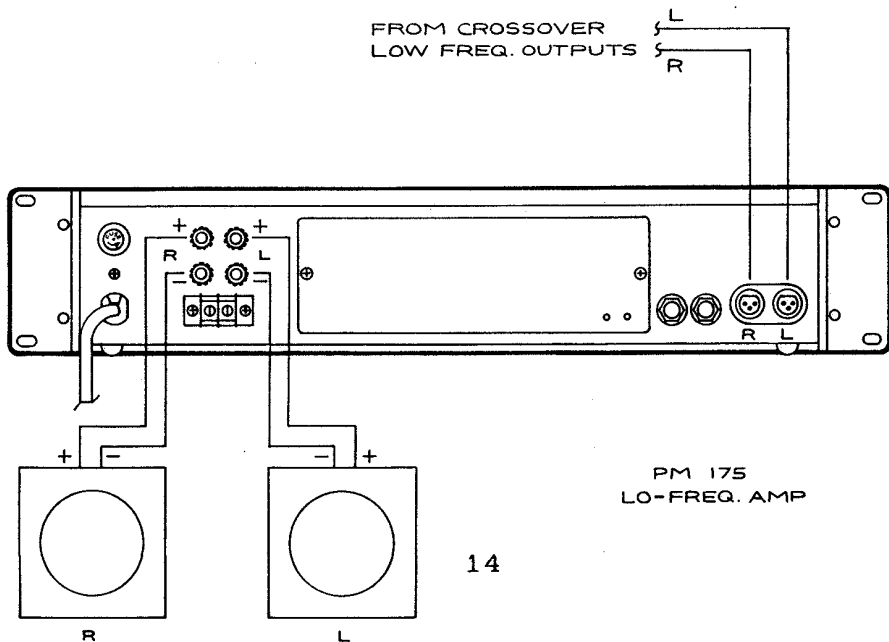
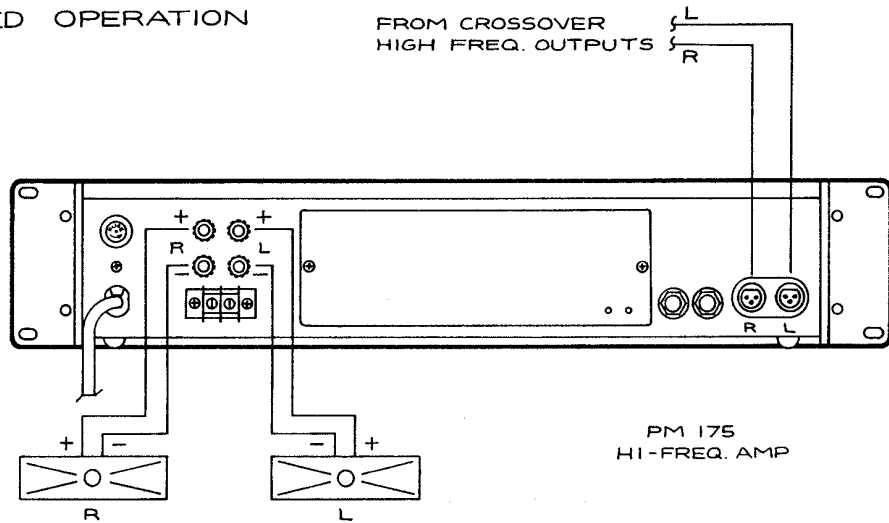

## MONO-BRIDGED OPERATIONS

The PM-175 may be used as a single-channel amplifier by setting-up and connecting it as follows.

MAKE SURE POWER IS OFF. Use a narrow screwdriver to push the Mono-bridge switch IN. This switch inverts the phase of the left-channel input signal which is necessary to operate in mono-bridge mode. Push the switch to its released position to return to Dual-Channel operation. Never activate this switch with the POWER on.

In balanced or unbalanced modes signal is supplied to the left channel input only. Use either the XLR connector or the TRS phone jack.

The PM-175 must be used with a loudspeaker with a nominal impedance of 8 ohms or greater when operating in mono-bridged mode. Connect the red binding posts of both output pairs to the loudspeaker. The red left channel binding post becomes the (-) and the red right channel binding post is the (+). If you are using dual-banana plugs for terminating the speaker wire, clock the locator tab on the (-) side so it is connected to the red left channel binding post for proper phasing of the output connections. See Figure 4.

FIG. 4 MONO - BRIDGED OPERATION

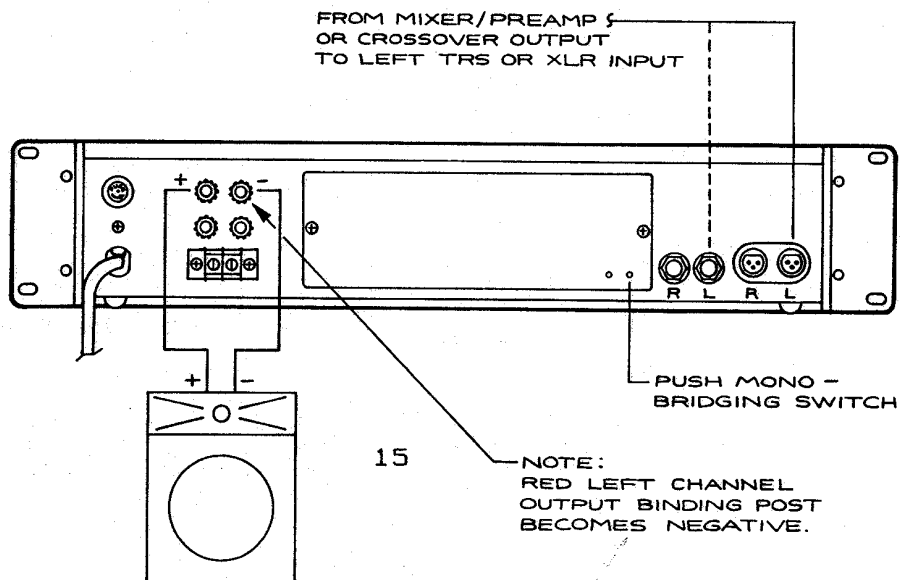



## DETERMINING BALANCED OR UNBALANCED

The connections are made in either balanced or unbalanced mode depending on your requirements and output capabilities of the components driving the PM-175. Check your mixer/preamp or signal processing component for balanced or unbalanced outputs. Selecting a mode depends on where and how the system is installed and operated. Running a balanced system reduces noise and rejects interference especially when it comes to long runs of snake cable or interconnect lines from the mixing console/crossover.

If you plan to operate a balanced system, make sure everything is balanced ie. balanced outputs from the console going to the balanced inputs on an equalizer or crossover going to the balanced inputs on the PM-175. If other amps are being supplied signal via the paralleled input connectors on the PM-175, these input connections must be balanced also. The same is true for unbalanced mode. KEEP YOUR CONNECTIONS EITHER ALL BALANCED OR ALL UNBALANCED. A mix of balanced and unbalanced can cause severe noise, hum or possible damage to the output circuitry on some balanced-drive, low-level components.

NOTE: The majority of system problems originate with improperly wired or faulty cables.

Make all connections to and from the PM-175 with its power switch OFF and the power for all other components in the system switched OFF or with line cords unplugged.

## BALANCED CABLE

Selecting which input connectors to use to supply drive signals depends on:

- 1) the output connectors on the component supplying signal. Signal may be supplied to the XLR or to the 1/4-inch TRS phone jacks or

2) the type of connectors used as terminations on the stage box of a multipaired snake cable.

The pin configurations for the PM-175's input connectors are:

1. Female XLR Inputs: the connectors are wired so that Pin 1 is ground, Pin 2 is (-) Low, Pin 3 is (+) High. Figure 5.

FIGURE 5

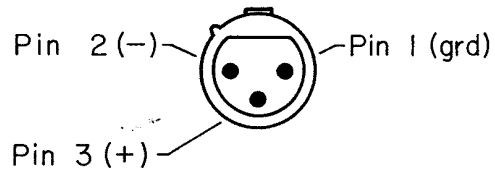

2. 1/4 inch TRS (Tip, Ring, Sleeve Inputs): These jacks are wired so that the Tip is (+) High, Ring is (-) Low, and the Sleeve is ground. Figure 6.

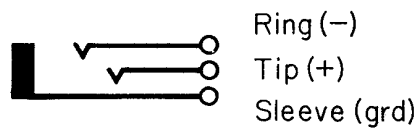

FIGURE 6

Balanced cord configurations should always be made in-phase. Examples:

Pin 1 on the PM-175's female XLR input corresponds to Pin 1 on a male XLR connector at the output of the component supplying drive signal.

Since the PM-175's input connectors are wired together in parallel, the unused connectors can supply signals when cascading several amplifiers with the same drive signal. However, the patch cords must be wired in balanced mode.

#### UNBALANCED CABLE

1. Female XLR-type Inputs: The cables supplying unbalanced drive signals are wired so the (+) is connected to Pin 3 and the ground to Pins 1 and 2. Figure 7.

FIGURE 7

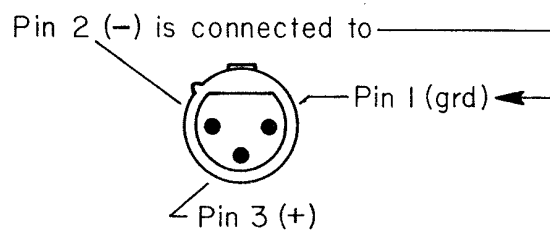

NOTE: Failure to connect Pins 1 and 2 will result in an approximate 50% reduction in gain.

2. 1/4-inch TRS (Tip, Ring, Sleeve) Inputs: The TRS 1/4" phone plugs are wired so that the tip is (+) and the ring and sleeve are wired to ground. When using standard (mono) 1/4" phone plugs, the ring and sleeve are automatically connected to ground. Figure 8.

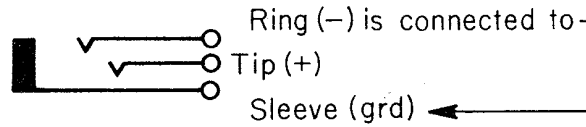

FIGURE 8

NOTE: Failure to connect ring and sleeve will result in an approximate 50% reduction in gain.

Signals to cascade amplifiers in the unbalanced mode are made ideally by supplying main drive signal to the XLR connectors. Use the standard (mono) 1/4" phone plugs to connect the other amplifiers.

#### SPEAKER WIRE

Use high quality speaker wire to connect the output terminals to the loudspeakers. While speaker wires as light as 16-gauge can be used to connect the amplifier to the loudspeakers, heavier-gauged speaker wires should be used in wire runs over long distances. Heavier speaker wires minimize line losses and will improve the damping factor.

The type of speaker wire connection depends on your system's application. For mobile sound systems, dual-banana plugs are a safe and convenient method of terminating speaker wires at the amplifier and loudspeakers. Dual-banana plugs have a locator tab along one side that is normally clocked so it denotes the (-) side of the terminals and speaker wire. For permanent installations, tinned leads or spade lugs provide excellent terminations.

Speaker wires may be purchased with the proper terminations and wire gauge for your amplifier and loudspeakers. If you are not sure how to put a good cable system together, consult your Carver Professional Products Dealer.

4. [ ] INITIAL POWER UP

WARNING: IMPROPER POWER UP/ POWER DOWN PROCEDURES  
MAY CAUSE DAMAGE TO LOUDSPEAKERS.

Make sure Power switch is OFF.

Turn left and right Level Controls to  
full counterclockwise position.

Push Power switch ON.  
Green Power LED lights.

Turn Level Controls to desired input  
sensitivity levels.

Red Signal LED should light when there is  
an audio output greater than 100 mW at  
either the right or left channel.

If Power LED or Signal LED does not light  
see Troubleshooting section.

5. [ ] FILL OUT AND MAIL WARRANTY CARD

## OPERATION

Do not operate the PM-175 into nominal loudspeaker impedances less than 4 ohms in dual channel operation, 8 ohms nominal loudspeaker impedances in mono-bridged mode.

## POWER UP

Reduce master gain controls on the instrument preamp or mixing console. Turn ON all low-level components in the sound system. This includes mixing consoles, on-stage instruments, effects devices, tape machines, signal processing equipment and crossovers. Turn ON the PM-175 and other amplifiers.

## POWER DOWN

Reduce master gain control levels at the preamp or console. Turn OFF the PM-175 and other amplifiers. Wait for their power supplies to discharge. Turn OFF the low-level equipment.

## POWER INTERRUPTION

Immediately reduce master gain controls at the preamp/mixer. Then restart the whole system when power is fully restored.

## PROTECTION SYSTEMS

Several protective circuits have been built-in to guard against major faults that could damage the amplifier or the loudspeakers.

Turn ON: "Slow startup" circuitry prevents an excessive AC line current surge when the amplifiers are turned on with the power ON/OFF switch or simultaneously by a Master Power AC line switch.

Input mute: The inputs are muted 4 seconds during turn-on. If low level driving equipment is accidentally turned on with the amplifiers, the input muting will prevent turn on "thumps" from reaching and possibly damaging the loudspeakers. The loudspeakers

will also be protected from this condition during momentary power failures.

Short circuit: Protect LED is lit. A short circuit load exists across either the left or right output binding posts. The output transistors are current limited. The inputs are muted to prevent the amplifier from driving into a short circuit condition. The amplifier will immediately resume normal operation when the fault is removed.

Excessive High-frequency signals (non-musical): Inputs are muted. The Protect LED is lit until the problem is eliminated. In excessive high frequencies, the protection circuits have been designed to react only to signals and oscillations that are different than any conceivable music signal. Generally, excessive high frequency feedback and preamp/mixer problems will activate these circuits.

DC Offset: Significant DC offset (2-4V DC) present at the outputs. Power output is significantly reduced. Protect LED is lit but dim.

Internal, Low-level Supply Fault: Internal component problem causing imbalance in the amplifier's low-level power supplies. Power output is significantly reduced.

Amplifier Overheated: Activated when the heatsink temperature exceeds 90 degrees C. All LED's are off.

Depending on the fault condition or problem that activates the PM-175's protection circuits, the amplifier will give a visual indication and/or simply shut itself off.

## MAINTENANCE

### Cleaning your Amplifier

Use a soft, dry cloth to wipe the front panel and chassis. For stubborn stains use a mild detergent sparingly on a soft cloth. Do not use ammonia, alcohol or other strong solvents.

## TROUBLESHOOTING

Most problems include faulty interconnect cables and cords. Check each cable and cord with a good cable tester. Replace any faulty cables before continuing with Troubleshooting.

PROBLEM	SOLUTION
LEDs Off at Power Up	Check AC line cord and power switches on outlet strip or power block.
All LEDs Off during operation	Check fuse and replace if necessary. If fuse is O.K. then: the amplifier has thermalled out and has reached a temperature greater than 90 degrees C or 194 degrees F. Bring Level Controls down, and when the unit has cooled to 65 degrees C the unit will automatically switch ON.
Protect LED (bright)	Inspect speaker wires for frays and shorts.  Check for high frequency oscillation at inputs caused by unstable driving equipment. Turn



	<p>down left and right Level Controls to full counterclockwise or oo. If LED goes out, replace faulty equipment.</p>
<p>Protect LED (dim) or ON LED (dim)</p>	<p>When dim more than a few seconds, an internal fault has occurred within the amplifier. This will indicate either a power supply failure or the presence of DC at either the Left or Right channel outputs. In this case servicing the amplifier will be required.</p>
<p>Amplifier gets wet</p>	<p>Have it dried and checked out by service personnel. Clean before returning it to operation.</p>
<p>Noise or hum</p>	<p>Certain sensitive low-level components might pick up noise or hum from the PM-175 or other power amplifiers. If this occurs, separate the components and amplifiers until noise stops. Another option is to install a heavy shielding plate between the components for the same results. If the amplifier is being driven in a BALANCED configuration, then the ground lead may be lifted on either Pin 1 of the XLR plugs or the sleeve on the TRS phone</p>

plugs. This ground shield must remain connected to the output of the driving equipment.

One channel dead

Check dead channel input cables. Inspect all connections to be sure of a firm fit in their respective jacks at the amplifier inputs and the outputs of the preamp/mixer.

Check the speaker leads at the amplifier's output binding posts and at the loudspeakers for disconnection.

Inspect the loudspeaker fuses.

Lack of bass

Check speaker wires for proper phasing. If in dual channel operation, check to see if the Mono-bridging switch is in its proper released position.

Main fuse blows

Replace ONLY with same type and rating. Using a larger fuse or fuse bypass can result in serious amplifier damage and will void the warranty.

The Amplifier may be running beyond its capacity.

- 1) SWITCH POWER OFF
- 2) UNPLUG AMPLIFIER

- 3)REPLACE FUSE
- 4)POWERUP AMPLIFIER

If fuse IMMEDIATELY blows again, remove amplifier for servicing.

#### Overheated

If the internal heatsink temperature should go over 90 degrees C or 194 degrees F, the amplifier will completely shut down until it has cooled. Check for adequate ventilation.